

NCP630

3.0 A Fast Linear Voltage Regulators

The NCP630 is a low dropout positive voltage regulator that is capable of providing a guaranteed output current of 3.0 A with a maximum dropout voltage of 1.25 V at 3.0 A over temperature. The fast turn on time allows step changes in loads commonly found in low voltage microprocessor applications. The NCP630 is currently offered as an adjustable output version that can be programmed down to 1.2 V with two external resistors and as a fixed output version at 3.47 V. On chip trimming adjusts the reference/output voltage to within $\pm 1.5\%$ accuracy. Internal protection features consist of output current limiting and thermal shutdown. NCP630 is available in D²PAK package.

Features

- Output Current of 3.0 A
- 1.25 V Maximum Dropout Voltage at 3.0 A Over Temperature
- Voltage on Shutdown Pin is TTL Compatible
- Reference/Output Voltage Trimmed to $\pm 1.5\%$
- Current Limit Protection
- Thermal Shutdown Protection
- -40°C to 125°C Junction Temperature Range

Applications

- Microprocessor Power Supplies
- DSP Power Supplies
- SMPS Post Regulation
- Battery Chargers

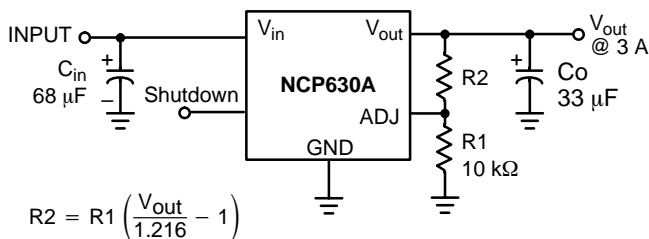

Figure 1. Typical Application Circuit for NCP630A

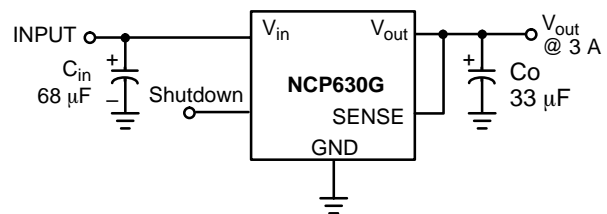

Figure 2. Typical Application Circuit for NCP630G



ON Semiconductor®

<http://onsemi.com>

MARKING DIAGRAM

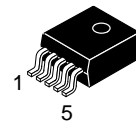

D²PAK
D2T SUFFIX
CASE 936A

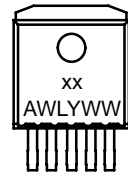

NCP630A

Tab = Ground
Pin 1. Shutdown
2. V_{in}
3. Ground
4. V_{out}
5. Adj

NCP630G

Tab = Ground
Pin 1. Shutdown
2. V_{in}
3. Ground
4. V_{out}
5. Sense

xx = Specific Device Code
A = Assembly Location
WL = Wafer Lot
Y = Year
WW = Work Week

ORDERING INFORMATION

See detailed ordering and shipping information in the package dimensions section on page 9 of this data sheet.

NCP630

MAXIMUM RATINGS

Rating	Symbol	Value	Unit
Input Voltage (Note 1)	V_{in}	12	V
Shutdown Voltage	Shutdown	-0.3 to $V_{in} + 0.3$	V
Output Voltage	V_{out}	-0.3 to $V_{in} + 0.3$	V
Output Short Circuit Duration (Note 2)	–	Infinite	–
Power Dissipation and Thermal Characteristics Case 936F (D ² PAK) Power Dissipation (Note 2) Thermal Resistance, Junction-to-Ambient Thermal Resistance, Junction-to-Case	P_D $R_{\theta JA}$ $R_{\theta JC}$	Internally Limited 45 5.0	W °C/W °C/W
Operating Junction Temperature Range	T_J	-40 to 125	°C
Storage Temperature Range	T_{stg}	-55 to 150	°C
Lead Soldering Temperature @ 260°C	T_{solder}	10	sec

- This device series contains ESD protection and exceeds the following tests:
Human Body Model JESD 22-A114-B
Machine Model JESD 22-A115-A
- The maximum package power dissipation is:

$$P_D = \frac{T_{J(max)} - T_A}{R_{\theta JA}}$$

PIN FUNCTION DESCRIPTION

Pin No.	NCP630A	NCP630G	Description
1	Shutdown	Shutdown	This input is used to place the NCP630 into shutdown mode. The NCP630 is active when a voltage greater than 2.0 V is applied. The NCP630 will be placed into a shutdown mode when a voltage less than 0.8 V is applied. If left unused then connect the pin high.
2	V_{in}	V_{in}	Positive power supply input voltage
3, Tab	Ground	Ground	Power supply ground
4	V_{out}	V_{out}	Regulated output voltage
5	Adj	–	This pin is to be Connected to the R_{sense} resistors on the output. It maintains 1.216 V between itself and ground. Refer to Figure 1 for equation.
5	–	Sense	This pin is to be connected near the load for better regulation.

NCP630

ELECTRICAL CHARACTERISTICS ($C_{in} = 68 \mu\text{F}$, $C_{out} = 33 \mu\text{F}$, $V_{in} = V_{out} + 1.5 \text{ V}$, $I_{out} = 10 \text{ mA}$, for typical value $T_J = 25^\circ\text{C}$, for min and max values $T_J = -40^\circ\text{C}$ to 125°C unless otherwise noted.)

Characteristic	Symbol	Min	Typ	Max	Unit
NCP630A					
Reference Voltage ($V_{in} = V_{out} + 1.5 \text{ V}$ to 7.0 V , $I_{out} = 10 \text{ mA}$ to 3.0 A , $T_J = 25^\circ\text{C}$) ($V_{in} = V_{out} + 1.5 \text{ V}$ to 7.0 V , $I_{out} = 10 \text{ mA}$ to 3.0 A , $T_J = -40^\circ\text{C}$ to 125°C)	V_{adj}	1.198 1.180	1.216 –	1.234 1.253	V
Line Regulation (Notes 3 and 4) ($V_{in} = V_{out} + 1.5 \text{ V}$ to 7.0 V , $T_J = 25^\circ\text{C}$) ($V_{in} = V_{out} + 1.5 \text{ V}$ to 7.0 V , $T_J = -40^\circ\text{C}$ to 125°C)	Reg_{line}	– –	0.02 0.06	– –	%
Load Regulation (Notes 3 and 4) ($I_{out} = 10 \text{ mA}$ to 3.0 A , $T_J = 25^\circ\text{C}$) ($I_{out} = 10 \text{ mA}$ to 3.0 A , $T_J = -40^\circ\text{C}$ to 125°C)	Reg_{load}	– –	0.01 0.06	– –	%
Dropout Voltage (Measured at $V_{out} - 2\%$) ($I_{out} = 300 \text{ mA}$) ($I_{out} = 3.0 \text{ A}$)	$V_{in} - V_{out}$	– –	0.75 1.0	1.0 1.25	V
Ground Pin Current in Normal Mode ($I_{out} = 300 \text{ mA}$) ($I_{out} = 3.0 \text{ A}$)	I_{Gnd}	– –	0.4 1.0	1.0 2.0	mA
Ground Pin Current in Shutdown Mode ($V_{shutdown} = 0.8 \text{ V}$)	I_{Gnd}	–	15	50	μA
Peak Output Limit	I_{out}	3.0	6.0	–	A
Short Current Limit (Note 5)	I_{SC}	–	6.5	–	A
Thermal Shutdown	–	–	165	–	$^\circ\text{C}$
Shutdown Input Threshold Voltage (Voltage Increasing, Output Turns On, Logic High) (Voltage Decreasing, Output Turns Off, Logic Low)	$V_{th(shutdown)}$	2.0 –	– –	– 0.8	V
Turn-off Delay, $I_{out} = 3.0 \text{ A}$	$T_{D(off)}$	–	20	–	μs
Turn-on Delay, $I_{out} = 3.0 \text{ A}$	$T_{D(on)}$	–	25	–	μs
Shutdown Input Low Current ($V_{Shutdown} = 0.8 \text{ V}$), (Negative current flows out of pin)	I_{IL}	–10	–5.0	–1.0	μA
Shutdown Input High Current ($V_{Shutdown} = 2.0 \text{ V}$), (Negative current flows out of pin)	I_{IH}	–10	–4.5	–1.0	μA
Ripple Rejection ($C_{out} = 100 \mu\text{F}$, $f = 1.0 \text{ kHz}$)	RR	–	85	–	dB
Output Noise Density ($f = 120 \text{ Hz}$)	–	–	0.6	–	$\mu\text{V}/\sqrt{\text{Hz}}$
Output Noise Voltage ($f = 20 \text{ Hz} - 100 \text{ kHz}$)	V_n	–	210	–	μV_{rms}

3. Low duty cycle pulse techniques are used during testing to maintain the junction temperature as close to ambient as possible.
4. Line regulation is defined as the change in output voltage for a change in input voltage. Load regulation is defined as the change in output voltage for a change in output load current at a constant temperature. The limits for line and load regulation are contained within the reference voltage specification, V_{adj} . Typical numbers are included in the specification for line and load regulation.
5. The short circuit limit is for device protection. Maximum output current is guaranteed to be greater or equal to 3.0 A with a 6.0 A typical as listed in the peak output limit specification.

NCP630

ELECTRICAL CHARACTERISTICS ($C_{in} = 68 \mu\text{F}$, $C_{out} = 33 \mu\text{F}$, $V_{in} = V_{out} + 1.5 \text{ V}$, $I_{out} = 10 \text{ mA}$, for typical value $T_J = 25^\circ\text{C}$, for min and max values $T_J = 0^\circ\text{C}$ to 125°C unless otherwise noted.)

Characteristic	Symbol	Min	Typ	Max	Unit
NCP630G					
Output Voltage ($V_{in} = 5.0 \text{ V}$ to 7.0 V , $I_{out} = 10 \text{ mA}$ to 3.0 A , $T_J = 25^\circ\text{C}$) ($V_{in} = 5.0 \text{ V}$ to 7.0 V , $I_{out} = 10 \text{ mA}$ to 3.0 A , $T_J = 0^\circ\text{C}$ to 125°C)	V_{out}	3.418 3.383	3.470 –	3.522 3.557	V
Line Regulation (Notes 6 and 7) ($V_{in} = 5.0 \text{ V}$ to 7.0 V , $T_J = 25^\circ\text{C}$) ($V_{in} = 5.0 \text{ V}$ to 7.0 V , $T_J = 0^\circ\text{C}$ to 125°C)	Reg_{line}	– –	0.02 0.06	– –	%
Load Regulation (Notes 6 and 7) ($I_{out} = 10 \text{ mA}$ to 3.0 A , $T_J = 25^\circ\text{C}$) ($I_{out} = 10 \text{ mA}$ to 3.0 A , $T_J = 0^\circ\text{C}$ to 125°C)	Reg_{load}	– –	0.01 0.06	– –	%
Dropout Voltage (Measured at $V_{out} - 2\%$) ($I_{out} = 300 \text{ mA}$) ($I_{out} = 3.0 \text{ A}$)	$V_{in} - V_{out}$	– –	0.75 1.0	1.0 1.25	V
Ground Pin Current in Normal Mode ($I_{out} = 300 \text{ mA}$) ($I_{out} = 3.0 \text{ A}$)	I_{Gnd}	– –	0.4 1.0	1.0 2.0	mA
Ground Pin Current in Shutdown Mode ($V_{shutdown} = 0.8 \text{ V}$)	I_{Gnd}	–	26	50	μA
Peak Output Limit	I_{out}	3.0	5.0	–	A
Short Current Limit (Note 8)	I_{SC}	–	5.0	–	A
Thermal Shutdown	–	–	165	–	$^\circ\text{C}$
Shutdown Input Threshold Voltage (Voltage Increasing, Output Turns On, Logic High) (Voltage Decreasing, Output Turns Off, Logic Low)	$V_{th(shutdown)}$	2.0 –	– –	– 0.8	V
Turn-off Delay, $I_{out} = 3.0 \text{ A}$	$T_{D(off)}$	–	20	–	μs
Turn-on Delay, $I_{out} = 3.0 \text{ A}$	$T_{D(on)}$	–	25	–	μs
Shutdown Input Low Current ($V_{in} = 0.8 \text{ V}$), (Negative current flows out of pin)	I_{IL}	–10	–5.0	–1.0	μA
Shutdown Input High Current ($V_{in} = 2.0 \text{ V}$), (Negative current flows out of pin)	I_{IH}	–10	–4.5	–1.0	μA
Ripple Rejection ($C_{out} = 100 \mu\text{F}$, $f = 1.0 \text{ kHz}$)	RR	–	85	–	dB
Output Noise Density ($f = 120 \text{ Hz}$)	–	–	0.6	–	$\mu\text{V}/\sqrt{\text{Hz}}$
Output Noise Voltage ($f = 10 \text{ Hz} - 100 \text{ kHz}$)	V_n	–	210	–	μV_{rms}

6. Low duty cycle pulse techniques are used during testing to maintain the junction temperature as close to ambient as possible.
7. Line regulation is defined as the change in output voltage for a change in input voltage. Load regulation is defined as the change in output voltage for a change in output load current at a constant temperature. The limits for line and load regulation are contained within the output voltage specification, V_{out} . Typical numbers are included in the specification for line and load regulation.
8. The short circuit limit is for device protection. Maximum output current is guaranteed to be greater or equal to 3.0 A with a 5.0 A typical as listed in the peak output limit specification.

Typical Characteristics

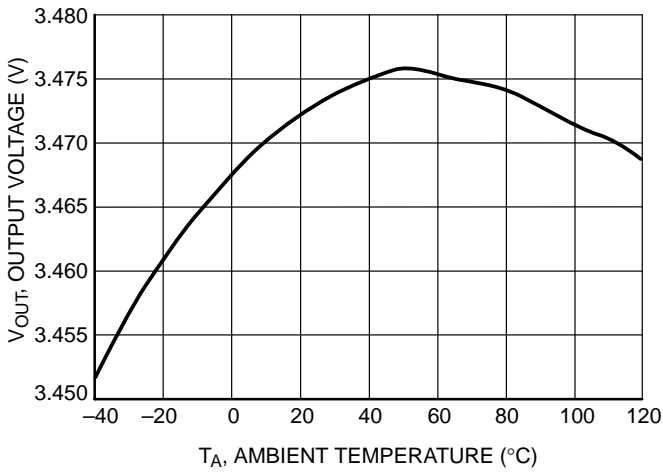

Figure 3. Output Voltage versus Temperature

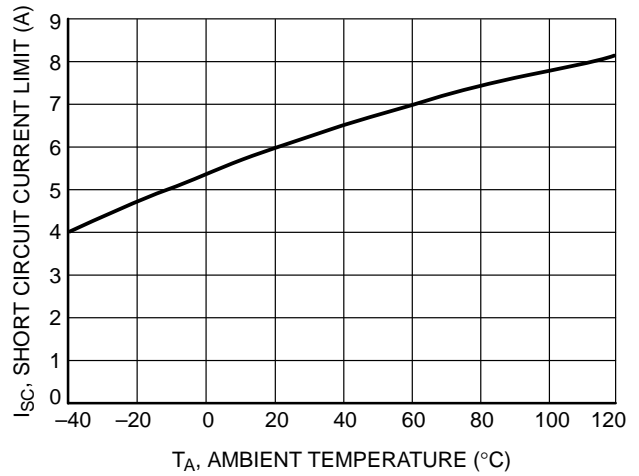

Figure 4. Short Circuit Current Limit versus Temperature

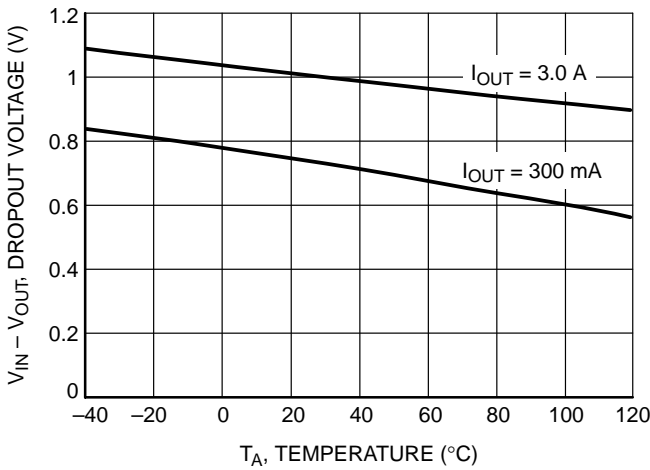

Figure 5. Dropout Voltage versus Temperature

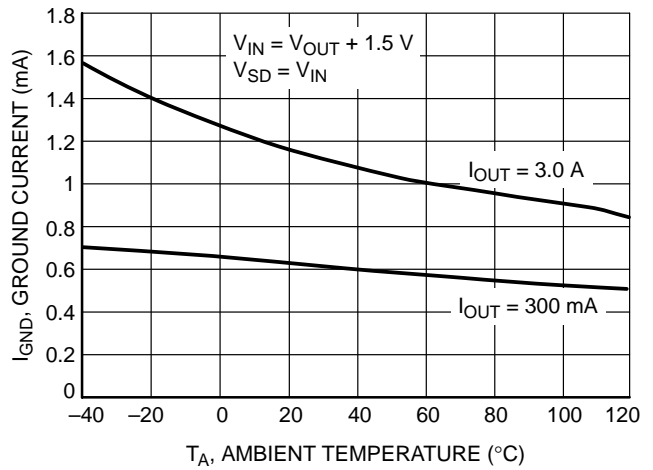

Figure 6. Ground Current versus Temperature

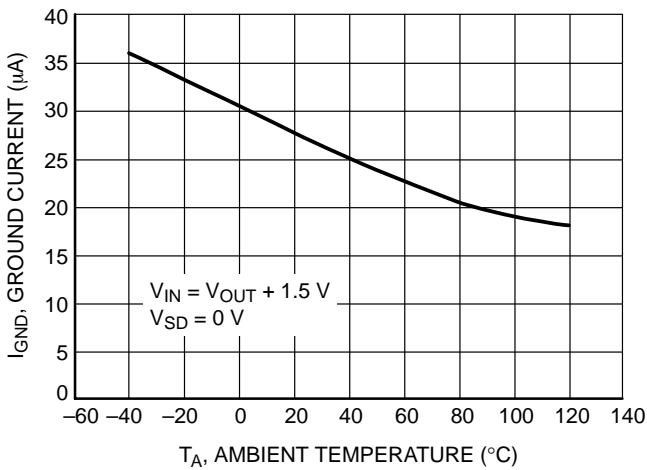

Figure 7. Ground Pin Current in Shutdown Mode versus Temperature

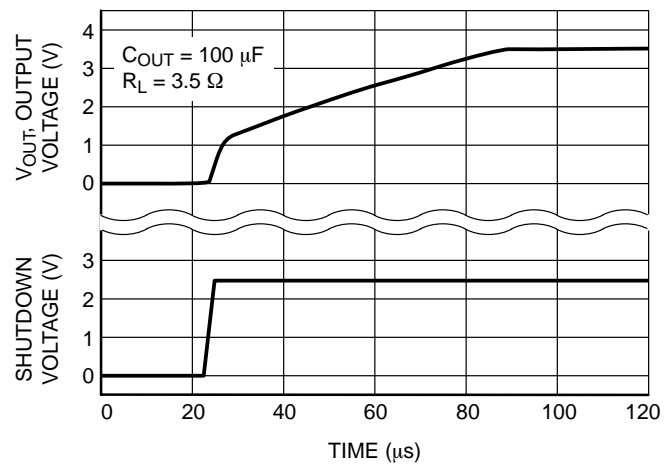

Figure 8. Start-up Transient

Typical Characteristics

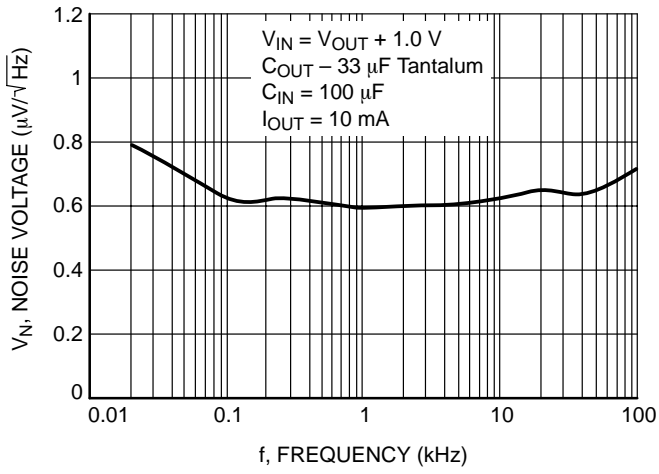

Figure 9. Output Noise Density

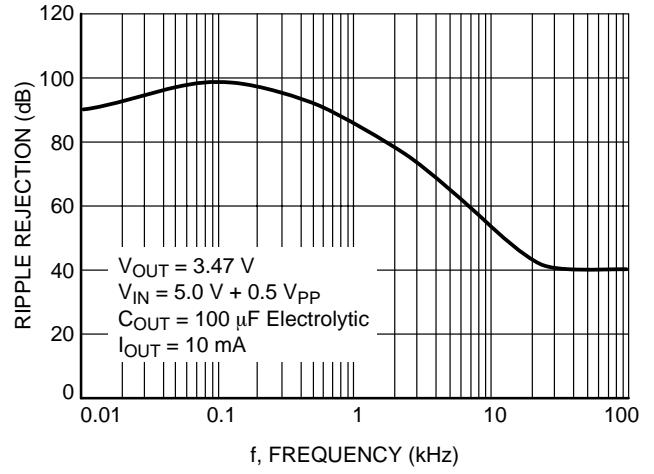

Figure 10. Ripple Rejection

APPLICATION INFORMATION

Input Capacitor

The minimum capacitance required for stability is a 68 μF aluminum electrolytic or tantalum capacitor. The maximum ESR allowed for stability is 5.0 Ω. The capacitor should be placed as close as possible to the input of the device.

The placement of a ceramic capacitor in parallel is not recommended due to possible instabilities.

Output Capacitor

A minimum output capacitor value of 33 μF is required for stability. The type of capacitor can be aluminum electrolytic or tantalum capacitor. ESR can vary up to a maximum of 2.0 ohms for stability. The capacitor should be placed as close as possible to the output of the device.

The placement of a ceramic capacitor in parallel is not recommended due to possible instabilities.

Sense Pin

The sense pin of the NCP630G will need to be connected near the output voltage. This provides great advantages when the linear regulator can't be near the load. The sense pin will monitor the load and allow the linear regulator to adjust for losses in the line between itself and the load. Thus it will provide good accuracy for a remote load.

ADJ Pin

The typical application circuits for the fixed and adjustable output regulators are shown in Figures 1 and 2. The adjustable devices develop and maintain the nominal 1.216 V reference voltage between the adjust and ground pins. The adjust pin current, I_{adj}, is typically 40 nA and normally lower than the current flowing through R1 and R2, thus it generates a small output voltage error that can usually be ignored. For the fixed output devices R1 and R2 are included within the device.

Reverse Current

Some situations might occur where the output pin is raised to a voltage while the input pin is at zero volts. This situation will not damage the device.

If the output voltage is raised to a higher voltage than the input voltage a diode is recommended from output to input with the anode connect to the output pin.

Thermal Considerations

This series contains an internal thermal limiting circuit that is designed to protect the regulator in the event that the maximum junction temperature is exceeded. When activated, typically at 165°C, the regulator output switches off and then back on as the die cools. As a result, if the device is continuously operated in an overheated condition, the output will appear to be oscillating. This feature provides protection from a catastrophic device failure due to accidental overheating. It is not intended to be used as a substitute for proper heatsinking. The maximum device power dissipation can be calculated by:

$$P_D = \frac{T_{J(max)} - T_A}{R_{\theta JA}}$$

The devices are available in surface mount D²PAK package. The package has an exposed metal tab that is specifically designed to reduce the junction to air thermal resistance, R_{θJA}, by utilizing the printed circuit board copper as a heat dissipater. Figure 11 shows typical R_{θJA} values that can be obtained from a square pattern using economical single sided 2.0 ounce copper board material. The final product thermal limits should be tested and quantified in order to insure acceptable performance and reliability. The actual R_{θJA} can vary considerably from the graphs shown. This will be due to any changes made in the copper aspect ratio of the final layout, adjacent heat sources, and air flow.

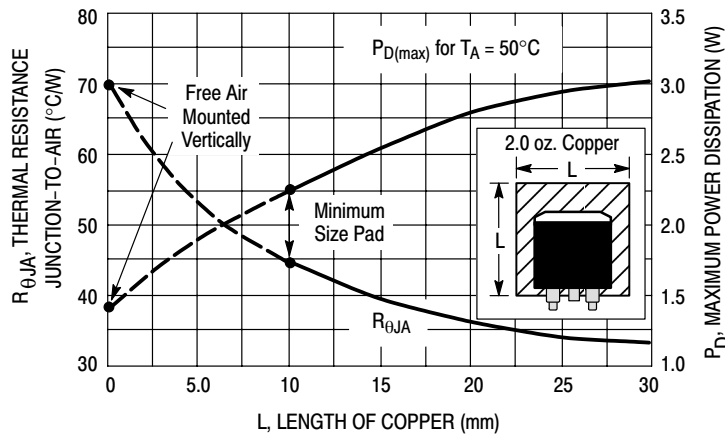
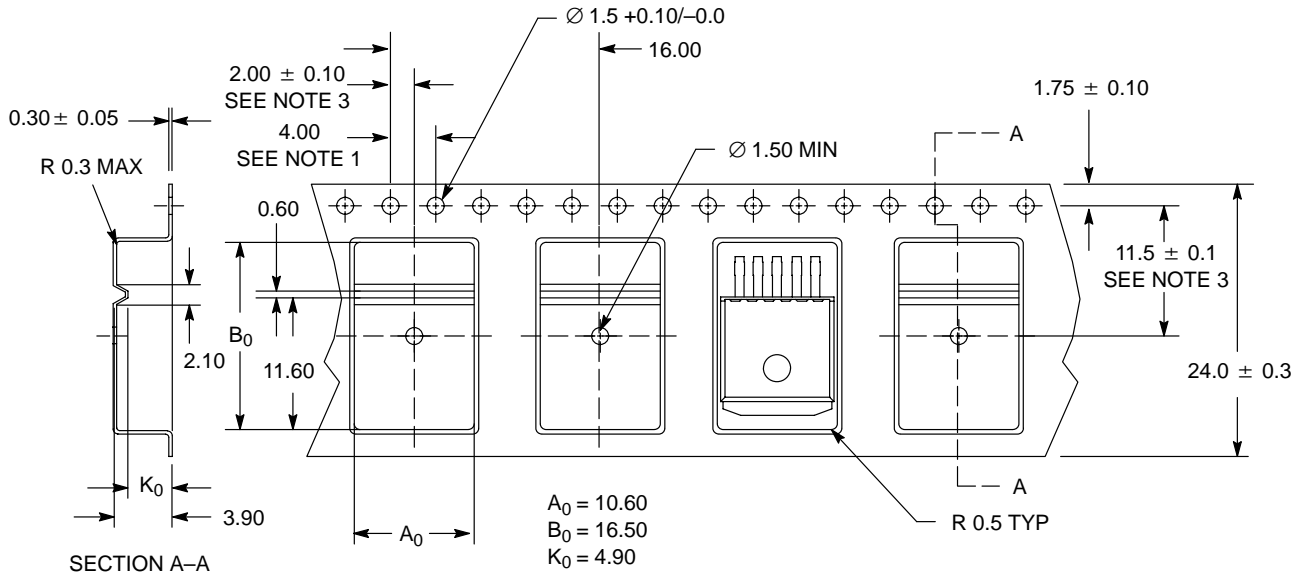

Figure 11. 3-Pin and 5-Pin D²PAK Thermal Resistance and Maximum Power Dissipation versus P.C.B. Copper Length

NCP630

TAPE AND REEL SPECIFICATION

SOP Description	Leads	Package Length	Package Width	Package Thickness	Reel Quantity	Tape Pitch	Tape Width	Vendor P/N
D ² PAK	5	9.2 mm	10 mm	4.4 mm	800	16 mm	24 mm	DSQPAK-K



NOTES:

1. 10 SPROCKET HOLE PITCH CUMULATIVE TOLERANCE ± 0.2
2. CAMBER IN COMPLIANCE WITH EIA 481
3. POCKET POSITION RELATIVE TO SPROCKET HOLE MEASURED AS TRUE POSITION OF POCKET, NOT POCKET HOLE

Figure 12. Package Carrier Dimensions

NCP630

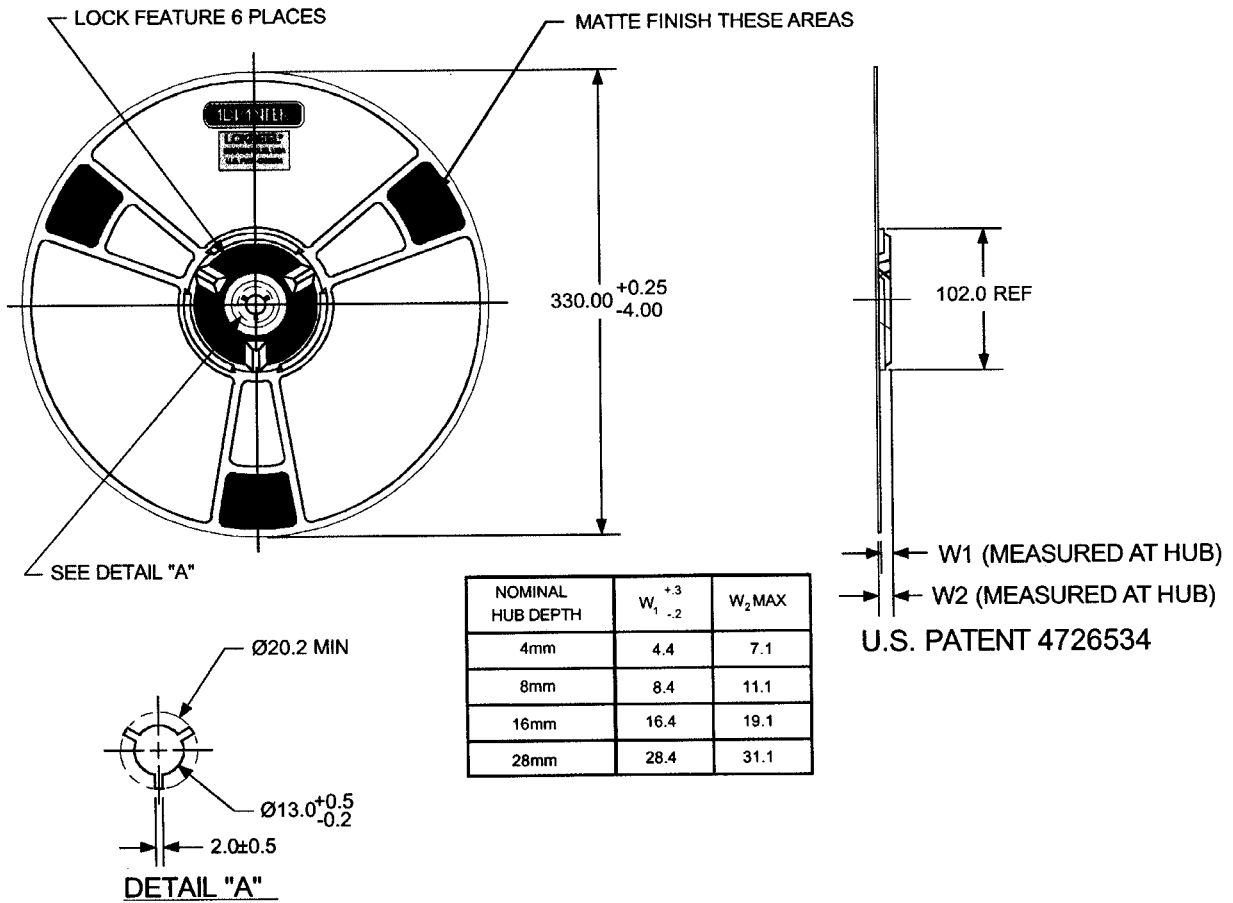

Figure 13. Reel Dimensions

ORDERING INFORMATION

Device	Marking	Nominal Output Voltage	Package	Shipping
NCP630AD2T	NCP630A	Adj	D ² PAK	50 Units/Rail
NCP630AD2TR4	NCP630A	Adj	D ² PAK	800/Tape & Reel
NCP630GD2T	NCP630G	3.47	D ² PAK	50 Units/Rail
NCP630GD2TR4	NCP630G	3.47	D ² PAK	800/Tape & Reel

NCP630

PACKAGE DIMENSIONS

D²PAK
D2T SUFFIX
CASE 936A-02
ISSUE B

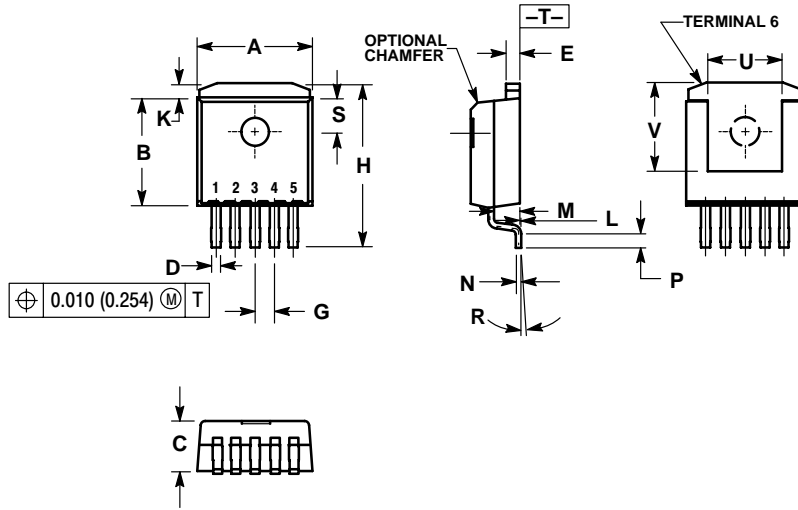

NOTES:

1. DIMENSIONING AND TOLERANCING PER ANSI Y14.5M, 1982.
2. CONTROLLING DIMENSION: INCH.
3. TAB CONTOUR OPTIONAL WITHIN DIMENSIONS A AND K.
4. DIMENSIONS U AND V ESTABLISH A MINIMUM MOUNTING SURFACE FOR TERMINAL 6.
5. DIMENSIONS A AND B DO NOT INCLUDE MOLD FLASH OR GATE PROTRUSIONS. MOLD FLASH AND GATE PROTRUSIONS NOT TO EXCEED 0.025 (0.635) MAXIMUM.

DIM	INCHES		MILLIMETERS	
	MIN	MAX	MIN	MAX
A	0.386	0.403	9.804	10.236
B	0.356	0.368	9.042	9.347
C	0.170	0.180	4.318	4.572
D	0.026	0.036	0.660	0.914
E	0.045	0.055	1.143	1.397
G	0.067 BSC		1.702 BSC	
H	0.539	0.579	13.691	14.707
K	0.050 REF		1.270 REF	
L	0.000	0.010	0.000	0.254
M	0.088	0.102	2.235	2.591
N	0.018	0.026	0.457	0.660
P	0.058	0.078	1.473	1.981
R	5° REF		5° REF	
S	0.116 REF		2.946 REF	
U	0.200 MIN		5.080 MIN	
V	0.250 MIN		6.350 MIN	

Notes

NCP630

ON Semiconductor and  are registered trademarks of Semiconductor Components Industries, LLC (SCILLC). SCILLC reserves the right to make changes without further notice to any products herein. SCILLC makes no warranty, representation or guarantee regarding the suitability of its products for any particular purpose, nor does SCILLC assume any liability arising out of the application or use of any product or circuit, and specifically disclaims any and all liability, including without limitation special, consequential or incidental damages. "Typical" parameters which may be provided in SCILLC data sheets and/or specifications can and do vary in different applications and actual performance may vary over time. All operating parameters, including "Typicals" must be validated for each customer application by customer's technical experts. SCILLC does not convey any license under its patent rights nor the rights of others. SCILLC products are not designed, intended, or authorized for use as components in systems intended for surgical implant into the body, or other applications intended to support or sustain life, or for any other application in which the failure of the SCILLC product could create a situation where personal injury or death may occur. Should Buyer purchase or use SCILLC products for any such unintended or unauthorized application, Buyer shall indemnify and hold SCILLC and its officers, employees, subsidiaries, affiliates, and distributors harmless against all claims, costs, damages, and expenses, and reasonable attorney fees arising out of, directly or indirectly, any claim of personal injury or death associated with such unintended or unauthorized use, even if such claim alleges that SCILLC was negligent regarding the design or manufacture of the part. SCILLC is an Equal Opportunity/Affirmative Action Employer.

PUBLICATION ORDERING INFORMATION

Literature Fulfillment:

Literature Distribution Center for ON Semiconductor
P.O. Box 5163, Denver, Colorado 80217 USA
Phone: 303-675-2175 or 800-344-3860 Toll Free USA/Canada
Fax: 303-675-2176 or 800-344-3867 Toll Free USA/Canada
Email: ONlit@hibbertco.com

N. American Technical Support: 800-282-9855 Toll Free USA/Canada

JAPAN: ON Semiconductor, Japan Customer Focus Center
4-32-1 Nishi-Gotanda, Shinagawa-ku, Tokyo, Japan 141-0031
Phone: 81-3-5740-2700
Email: r14525@onsemi.com

ON Semiconductor Website: <http://onsemi.com>

For additional information, please contact your local Sales Representative.